

IMPLEMENTATION OF ARTIFICIAL NEURAL NETWORK BASED CLOSED LOOP CONTROL FOR A CASCADED H BRIDGE MULTI LEVEL INVERTER

PASUPULETI SAIRAM¹ & SATYANARAYANA V²

¹Pg Scholar, Department of Electrical and Electronics Engineering, Ramachandra College of Engineering, Andhra Pradesh, India

²Associate Professor, Department of Electrical and Electronics Engineering, Ramachandra College of Engineering, Andhra Pradesh, India

ABSTRACT

Multi level inverters are gaining attraction because of the inherent advantages like low switching losses and less voltage stress which results in low filter cost. The common techniques that are available for switching the multi level inverters are based on sinusoidal pulse width modulation and using conventional PI based controllers, hysteresis based controllers. These controllers suffer with slow response time this makes usage of multi level inverters in custom power devices difficult. Because custom power devices require fast acting controller action which can be achieved by intelligent controllers. In this project artificial neural network based modulation scheme is designed and implemented for a cascaded H bridge inverter. The response time of controller for different operating power factors of the load are compared with conventional PI controllers and are presented. The developed control technique is developed by using SimPowerSystems Block set of MATLAB/SIMULINK Release R2015a.

KEYWORDS: Closed Loop Control Techniques, Neural Network Controllers, Scaled Conjugate Gradient Algorithm

INTRODUCTION

The various types of controllers employed in applications with power converters as controlled source can be basically divided into two main groups. Linear and nonlinear controllers. Hysteresis and sliding mode controllers are examples of nonlinear controllers and proportional (P), proportional integral (PI), and proportional derivative controllers are examples of linear controllers [1]. But these types of conventional controllers experiences sluggish response which means response time is high which in turn make it difficult to use in custom power devices[2]. most of the industrial loads are sensitive nature there may be huge variations in the final output even half cycle of power supply distorted, so, controllers we are used in the applications must be in nature of fast acting and this can be achieved by the artificial neural network. Now a days artificial neural network becomes popular due to various advantages like adaptive learning, self-organisation, and real time operation etc.

Proportional controller is one of the types of linear feedback control system. P type of control is complicated than that of bang bang controller. But P type of controller is simplest than that of PID controllers. P type of control is unable to stabilize higher order harmonics. It can stabilize only first order harmonics [3],[4].

Now a day's most widely adopted controller for industrial application is PI controller because of numerous advantages like easy to design and low cost. PI controller have one disadvantage that is it will fail when the controlled

object is highly non linear and inexact. PI control can have the ability to mitigate steady state error and forced oscillations [5]. 98% of the control techniques used in the pulp and paper industries are controlled by single input single output PI controllers [6]. Most of the industrial controllers adopt PID controllers. PID controllers can have the ability to deal with higher order harmonics. 95% of the industrial controllers are PID controllers [7].

The current control methods can play vital role in power electronic circuits [8]. Among the conventional closed loop controllers hysteresis control is used very often because of its simplicity and also it have numerous advantages like this method does not require any acquaintance of load parameters[9].Hysteresis current control is one of the feedback current control method where the load current trailing the reference current within the band. The controller generates the sinusoidal reference current of reference current of desired magnitude and frequency that is measured with the actual line current. If that exceeds the upper limit of the hysteresis band the next higher level voltage should be selected to attempt to force the current towards zero [10].

Sliding mode controllers can be considered as best controller with high stability with a wide range of operating conditions. It cannot be applied to multi switch power electronic converters [11].

Coming to the artificial neural networks the fastest training algorithm is Levenberg-Marquardt algorithm and this algorithm is the default training algorithm for feed forward networks. The quasi Newton method is also quite fast. Both of these methods tend to be less efficient for larger networks, since they require more memory and more computation time [12],[18]. When training large networks scaled conjugate gradient algorithm and resilient back propagation algorithm are better choices. Their memory requirements are relatively small and much faster than standard gradient algorithms [13].

In this project scaled conjugate gradient algorithm is used to train the algorithm. It uses gradient calculations which are more efficient than the Jacobin calculations the other two algorithms are levenberg-marquardt, Bayesian regulation [14]. SCG is fully automated including no user dependent parameters and avoids a time consuming line search.

PROPOSED CONTROL TECHNIQUE

Artificial neural network is information behaviour towards paradigm that is inspired by the way biological nervous system, such as brain and processing system. Artificial neural networks take different approach than conventional controllers. Artificial neural networks are divided into two types one is feed forward networks and another one is feedback networks. Feed forward artificial neural networks allow to travel signals in only one way. Whereas feedback networks can have signals travelling in both directions.The common type of artificial neural networks consists of three groups input layers are connected to hidden layers and hidden layers are connected to an output layers. The activity of input layers represents the raw information that is fed to the network. The activity of each hidden layer is determined by activity of input layers and weights of the connections between the input layers and hidden layers. The behaviour of the output layers depends on the activity of the hidden layers and the weights between hidden layers and output layers.

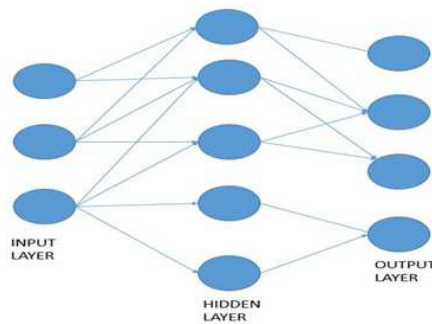

Figure 1: Artificial Neural Network

Feed forward networks recurrently have one or more hidden layers of sigmoid neurons followed by an output layer of linear neurons. There are two different ways in which training can be implemented incremental mode and batch mode. In incremental mode gradient is computed and the weights are updated after each input is applied to the network. In batch mode all the inputs in the training set are enforced to the network before the weights are updated.

Training algorithm updates the network weights and biases in a direction in which performance function decreases most rapidly.

$$x_{k+1} = x_k - \alpha_k g_k$$

x_k -----vector of current weights and biases

g_k -----current gradient

α_k -----learning rate

In this proposed scheme scaled conjugate gradient algorithm is used to train the algorithm. It uses gradient calculations which are more efficient than the Jacobin calculations the other two algorithms are levenberg-marquardt, Bayesian regulation. SCG is fully programmed including no user dependent parameters and avoids a time consuming line search.

MULTILEVEL INVERTERS – CONTROL TECHNIQUES

Numerous publications on the theories related to detection and measurement of the various system variables for reference signals estimation are reported. Figure 2 illustrates the considered reference signal estimation techniques proposed by Motano et al (2002) and Gobrio et al (2008). This section presents the considered reference signal estimation techniques, providing for each of them a short description of their basic features [15].

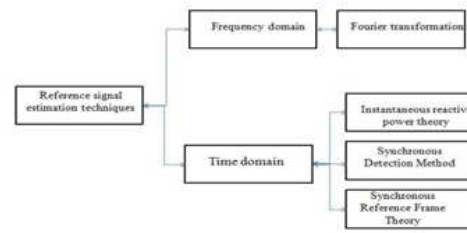

Figure 2: Reference Signal Estimation Techniques

Time Domain Approaches

Time-domain approaches are based on instantaneous estimation of reference signal in the form of either voltage or current signal from distorted and harmonic polluted voltage and current signals. These approaches are applicable to both single-phase and three-phase systems except for the Synchronous Detection Method and Synchronous Reference Frame theorem which can only be adopted for three-phase systems.

Instantaneous Reactive Power Theory (P-Q Theory)

The instantaneous reactive power theory otherwise known as p-q theory is proposed by Akagi et al (2007). This theorem is based on $dq0$ transformation which transforms three-phase voltages and currents into the \ddot{u} -0 stationary reference frame. From these transformed quantities, the instantaneous active and reactive power of the nonlinear load is calculated, which consists of a DC component and an AC component. The AC component is extracted using HPF and taking inverse transformation to obtain the compensation reference signal in terms of either current or voltage. This theorem is suitable only for a three-phase system and its operation takes place under the assumption that the three-phase system voltage waveforms are symmetrical and purely sinusoidal. If this technique is applied to contaminated supplies, the resulting performance is proven to be poor. In order to make the p-q theory applicable for a single-phase system, some modifications in the original p-q theory was proposed and implemented by Czarnecki (2004), (2006) [16].

Synchronous Detection Method (SDM)

The Synchronous Detection Method is very similar to the p-q theory. This technique is suitable only for a three-phase system and its operation relies on the fact that three-phase currents are balanced. It is based on the idea that the AF forces the source current to be sinusoidal and in phase with the source voltage despite load variations. The average power is calculated and divided equally between the three phases. The reference signal is then synchronized relative to the source voltage for each phase as discussed by Chen et al (1993). Although this technique is easy to implement, it suffers from the fact that it depends to a great extent on the harmonics in the source voltage.

Synchronous Reference Frame Theory (D-Q Theory)

This theorem relies on the Park's Transformations to transform the three phase system voltage and current variables into a synchronous rotating frame. Active and reactive components of the three-phase system are represented by direct and quadrature components respectively as given by Bhattacharya et al (1995). In this theorem, the fundamental components are transformed into DC quantities which can be separated easily through filtering. This theorem is applicable only to a three-phase system. The system is very stable since the controller deals mainly with DC quantities. The

computation is instantaneous but incurs time delays in filtering the DC quantities [17].

Frequency Domain Approaches

Reference signal estimation in frequency-domain is suitable for both single and three phase systems. It is mainly derived from the principle of Fourier analysis as follows:

Fourier Transform Techniques

In principle, either conventional Fourier Transform (FT) or Fast Fourier Transform (FFT) is applied to the captured voltage / current signal. The harmonic components of the captured voltage / current signal are first separated by eliminating the fundamental component. Inverse Fourier Transform is then applied to estimate the compensation reference signal in the time domain. The main drawback of this technique is the accompanying time delay in the sampling of system variables and computation of Fourier coefficients.

This makes it impractical for real-time applications with dynamically varying loads. Therefore, this technique is only suitable for slowly varying load conditions. In order to make computation much faster, some modifications were proposed and implemented. In this modified Fourier-series scheme, only the fundamental component of current is calculated and this is used to separate the total harmonic signal from the sampled load current waveform.

IMPLEMENTATION OF ANN BASED CLOSED LOOP CONTROL SCHEME

Procedure for implementation of ANN based closed loop control can be explained with the help of the following steps

- Instantaneous values of output voltages are measured.
- The time dependent voltages are converted into time independent quantities using Park's Transformation.
- The time independent voltages are compared with the desired quantities and error is evaluated. .
- The error thus obtained is used for generation of modulating signals.
- The error thus obtained in step 4 and change in error is taken as inputs for ANN based control circuit.
- The neural network is designed using 4 inputs, 10 hidden layers and 10 outputs. The two outputs of the neural network are V_d and V_q .
- The zero sequence component of voltage is taken as zero.
- The time independent voltages are converted into time varying quantities using inverse Park's transformations..
- Neural network that was used in control circuit is trained using SCG algorithm and is shown in Figure 3.

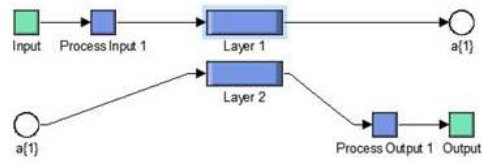

Figure 3: Schematic Diagram of Algorithm

For layer1 tansig function and for layer2 purelin functions are used as activation functions. The network consists of 10 hidden layers as shown in Figure 4. The weights biases for 10 outputs at the time instant of 0.2 are shown in Table – 1.

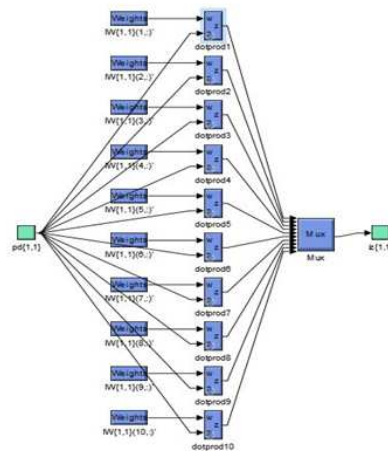

Figure 4: Hidden Layers of the Network

Table 1: The Values of Weights and Biases of the Network

Layer No	Biases	Weights	Outputs
Layer 1	-2.513	0.4062	0.9709
Layer 2	1.863	0.1895	0.9675
Layer 3	-1.172	-0.71	0.9547
Layer 4	-0.8116	-0.07676	0.7106
Layer 5	0.5141	0.4844	0.761
Layer 6	-0.2403	1.278	0.7772
Layer 7	-0.9344	1.232	0.2894
Layer 8	-1.32	0.5433	0.6511
Layer 9	1.938	0.2756	0.9764
Layer 10	2.533	0.07927	0.9893

ARTIFICIAL NEURAL NETWORK APPLIED CASCADED H BRIDGE MULTI LEVEL INVERTER

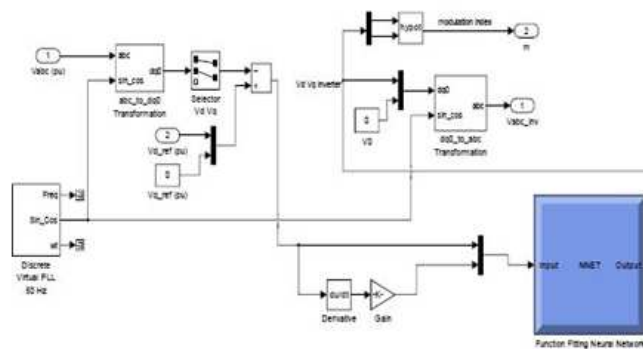

Figure 5: Artificial Neural Network Applied to 11 Level Cascaded H Bridge Multi Level Inverter

Implemented closed loop control scheme is applied to the 11 level cascaded H bridge multi level inverter and this is developed in the MALAB / SIMULINK 2015a.and the obtained results are as follows.

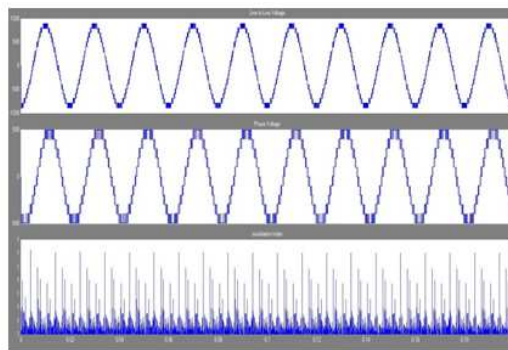

Figure 6: Line Voltage and Phase Voltage with Modulation Index Equal to 1

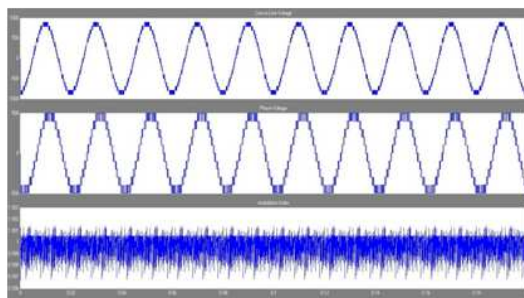

Figure 7: Line Voltage and Phase Voltage with Modulation Index Equal to 0.9

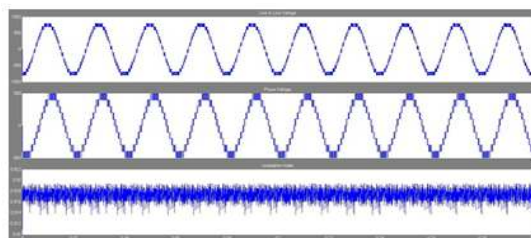

Figure 8: Line Voltage and Phase Voltage with Modulation Index Equal to 0.8

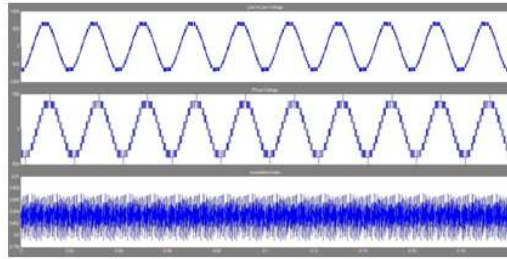

Figure 9: Line Voltage and Phase Voltage with Modulation Index Equal to 0.7

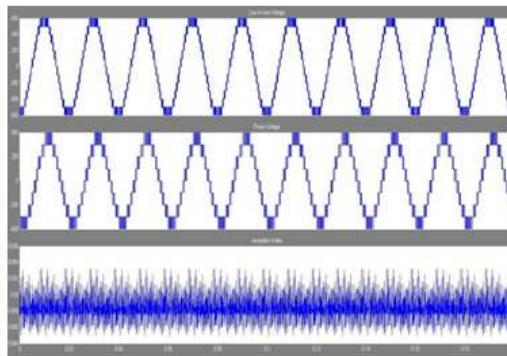

Figure 10: Line Voltage and Phase Voltage with Modulation Index Equal to 0.6

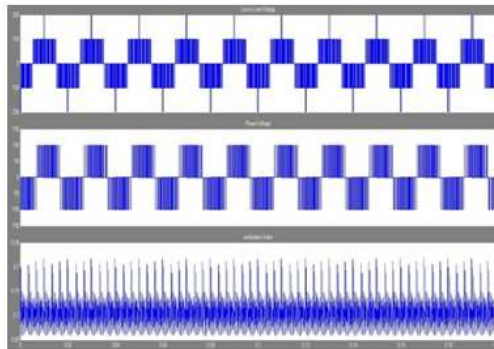

Figure 11: Line Voltage and Phase Voltage with Modulation Index Equal to 0.5

In this results obtained from the artificial neural network are compared with conventional pi controller and the results are as follows.

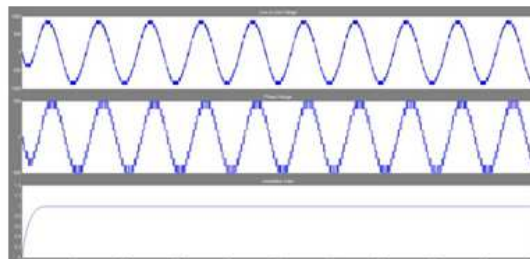

Figure 12: Line Voltage and Phase Voltage with Modulation Index Equal to 1 by Using PI Controller

When using PI controller response time is increased and the system takes more than half cycle to settle but in the case neural network controller response time is considerably decreased.

CONCLUSIONS

Most of the loads are sensitive to changes in voltage variations there may be adverse affects if the faults persisted more than a half cycle. In this paper it was noticed that response time of the system is considerably increased when the inverter system is controlled with artificial neural network based controller. It is observed that the ANN Based controllers give a fast transient response when compared with PI based conventional Controllers. It is found that the ANN based controller takes $4\mu\text{s}$ of time for attaining steady state value where as PI based controller applied to same converter takes $2\mu\text{s}$ of time to attain its steady state value.

REFERENCES

1. V.M. Deshmukh, A.J. Patil, Comparison and performance analysis of closed loop controlled nonlinear system connected PWM inverter based on hybrid technique, Journal of Electrical Systems and Information Technology 2 (2015) 86–98.
2. Ismail, N; Abdullah, W. N. W. Enhancement of power quality in distribution system using D-STATCOM, Power Engineering and Optimization Conference (PEOCO), 2010 4th International.
3. Çolak I, Kabalci E. The control methods of multi-level inverter TUBAV Sci 2009; 1:45–54.
4. Ilhami Colak, Ersan Kabalci, R. Bayindir Review of multilevel voltage source inverter topologies and control schemes. Energy Convers Manage, ENERGY CONVERSION AND MANAGEMENT · FEBRUARY 2011.
5. Chinnaiyan VK, Jerome J, Karpagam J, Suresh T. Control techniques for multilevel voltage source inverters. In: Proceedings of the 8th IEEE int power engineering conference, Mandarin (Singapore); 2007.
6. K Smriti Rao, Ravi Mishra Comparative study of P, PI and PID controller for speed control of VSI-fed induction motor, © 2014 IJEDR | Volume 2, Issue 2 | ISSN: 2321-9939.
7. Raghavendra M, S Ramanand, H. Naganagouda, New Grid connected PV system Using Reduced Switch Multilevel Inverter and PID controller, International Journal of Innovative Technology and Exploring Engineering (IJITEE) ISSN: 2278-3075, Volume-4 Issue-4, September 2014.
8. S. Buso, L. Malesani, P. Mattavelli, "Comparison of Current Control Techniques for Active Filter Applications", IEEE Transaction on Industrial Electronics, Vol. 45, No.5, October 1998., pp.722-729
9. B.K. Bose,"An Adaptive Hysteresis-Band Current Control Technique of a Voltage-Fed PWM Inverter for Machine Drive System", IEEE Transactions on Industrial Electronics, Vol. 37, No.5, October 1990., pp. 402-408.
10. L. Malesani, P. Mattavelli, "Novel Hysteresis Control Method for Current Controlled Voltage-Source PWM Inverters with Constant Modulation Frequency", IEEE Transaction on Industry Applications, Vol. 26, No. 1, January/February 1990., pp. 88-92

11. Carpita, M. ricerche, sliding mode controlled iverter with switching techniques,E.P.E journal,vol 4 september 1994
12. Hao Yu, Auburn University and Bogdan M. Wilamowski, Auburn University “Levenberg–Marquardt Training”
13. Haradhan Chel, Aurpan Majumder, Debashish Nandi, Scaled Conjugate Gradient Algorithm in Neural Network Based Approach for Handwritten Text Recognition Volume 204 of the series Communications in Computer and Information Science pp 196-210
14. Cho, S.-B.: Neural-Network Classifiers for Recognizing Totally Unconstrained Handwritten Numerals. IEEE Trans. on Neural Networks 8, 43–53 (1997)
15. Subhashish Bhattacharya Deepak Divan “Synchronous frame based controller implementation for a hybrid series active filter system” IEEE-conference paper pp. 2531-40, 1995.
16. Fang Zheng Peng, Jih-Sheng Lai, "Generalized Instantaneous Reactive Power Theory for Three phase Power system," IEEE Transactions on Instrumentation and Measurement, Vol.45, No.1, Page(s): 293 - 297, 1996.
17. Krause, P.; Wasynczuk, O.; Sudhoff, S. Reference-Frame Theory
18. Moller, Neural Networks, Vol. 6, 1993, pp. 525–533.